

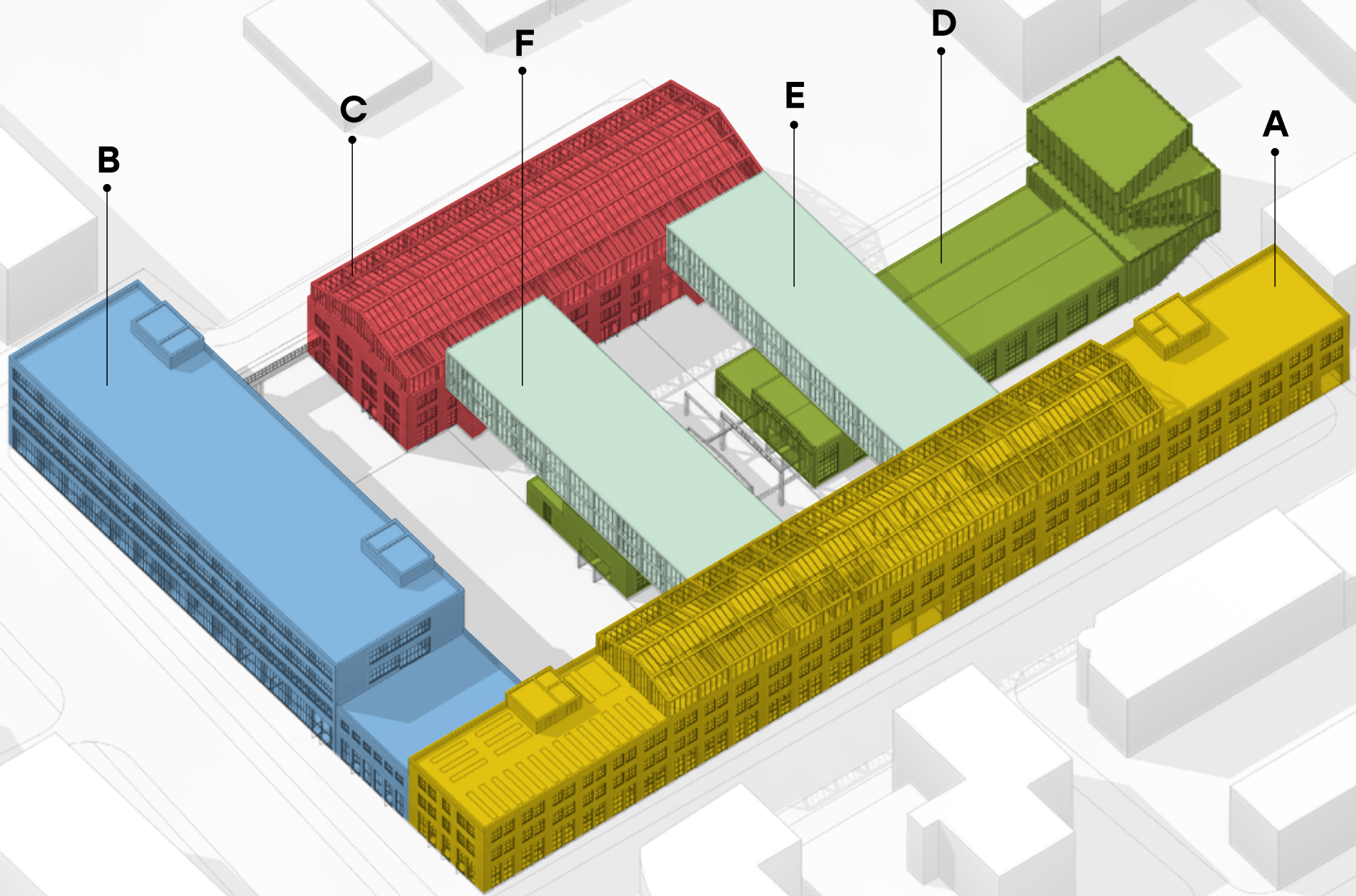

PROMPRYLAD
RENOVATION

PROMPRYLAD. RENOVATION

BUILDINGS



ESTIMATED BUDGET STAGES

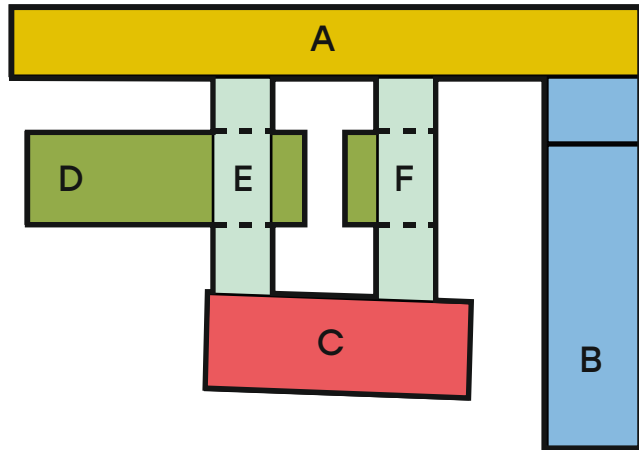

(the cost of repairs is approximate and can not be accepted as final)

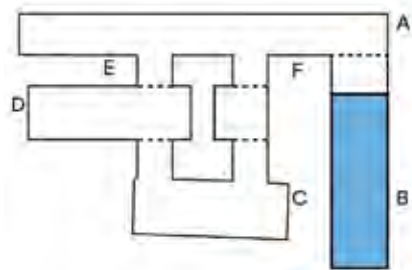

1 BILDING B
 Start - 01.01.2020
 Finish - 1.09.2020
 Approximate cost of 1 m² repair works - \$ 400

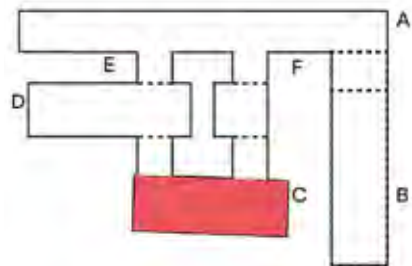

2 BILDING C
 Start - 01.01.2020
 Finish - 01.02.2021
 Approximate cost of 1 m² repair works - \$ 600

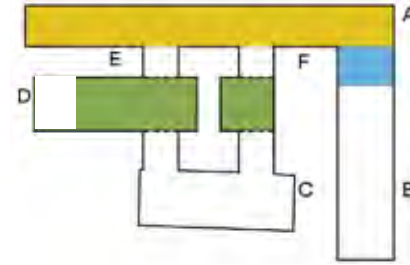

3 BILDING A/B/D (partially)
 Start - 01.01.2020
 Finish - 01.12.2021
 Approximate cost 1 m² repair works:
 bilding A - 800 \$
 bilding B - 400 \$
 bilding D - 300 \$

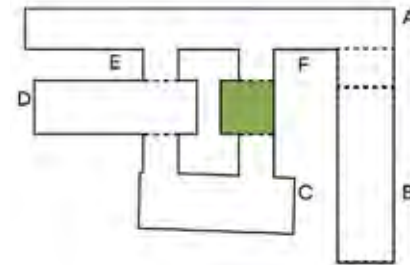

4 BILDING D
 Start - 01.01.2020
 Finish - 01.12.2021
 Approximate cost of 1 m² repair works - 700 \$

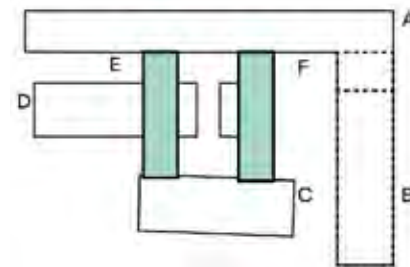

5 BILDING E/F
 Start - 01.01.2022
 Finish - 01.02.2024
 Approximate cost of 1 m² repair works - \$ 1200

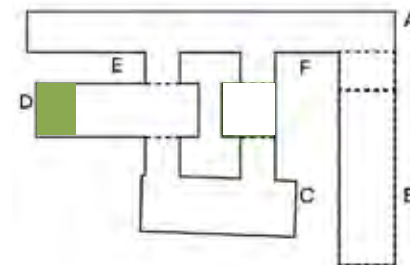

6 BILDING D
 Start - 01.01.2020
 Finish - 01.12.2021
 Approximate cost of 1m2 repair works - 1200 \$

REALISATION STAGES

1

EXISTING
BUILDINGS

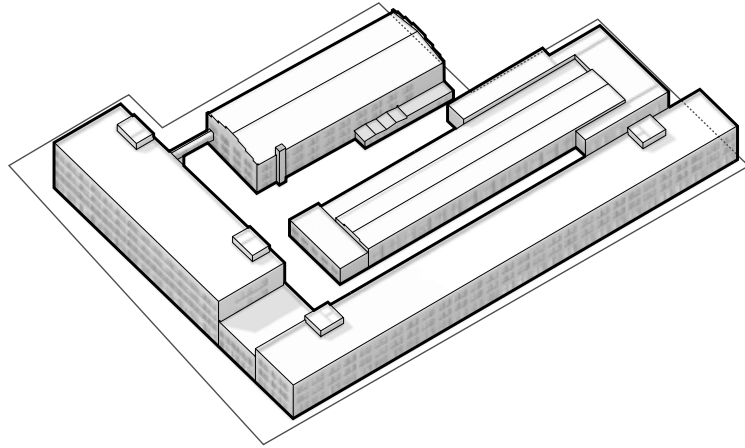

2

DISMANTLING

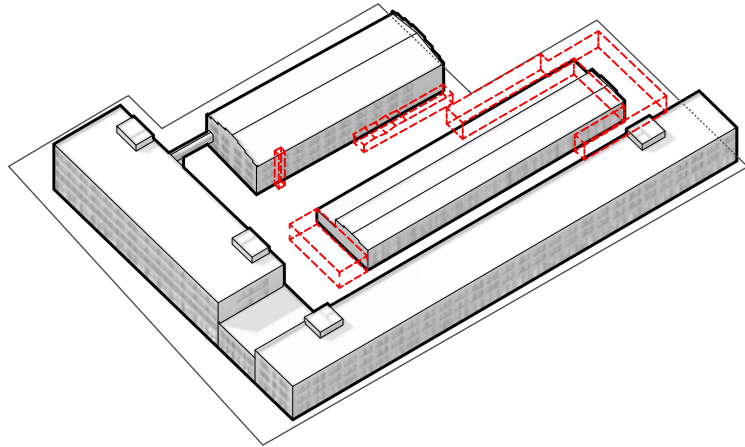

3

PORTAL
CREATION

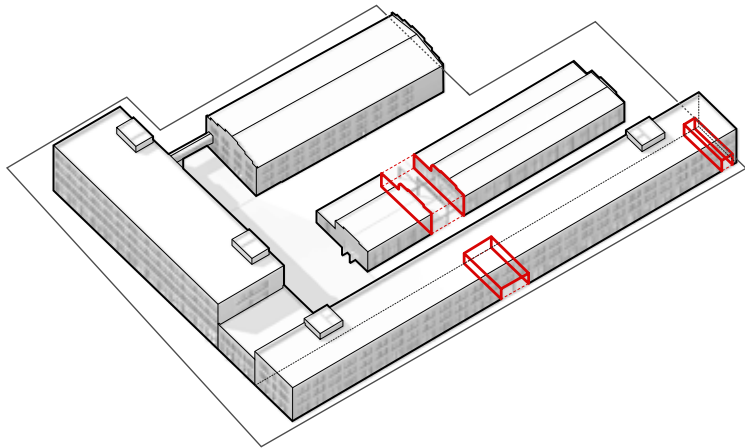

4

CREATION
MANSARDS
AND COMMUNICATON
CORE'S

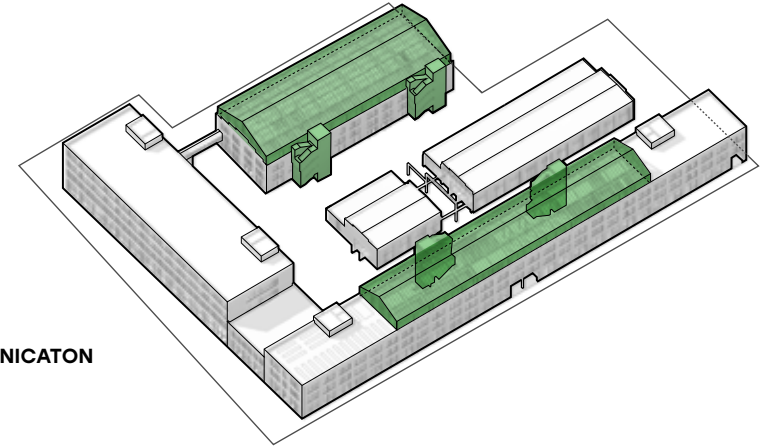

5

CREATION
OFFICE BLOCKS

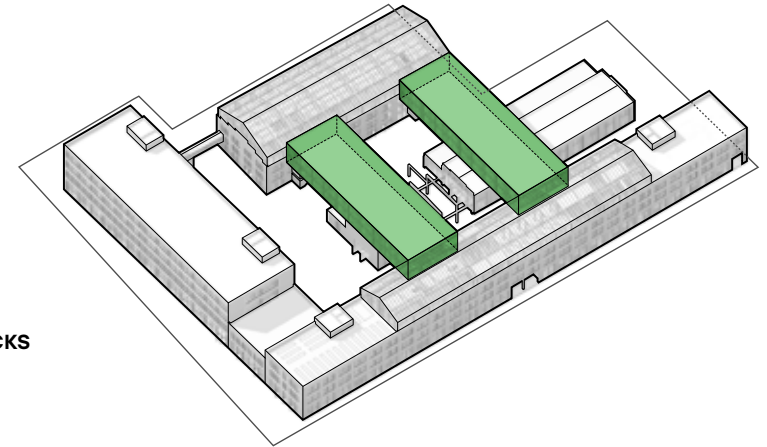

6

CREATION
CINEMA CENTRE

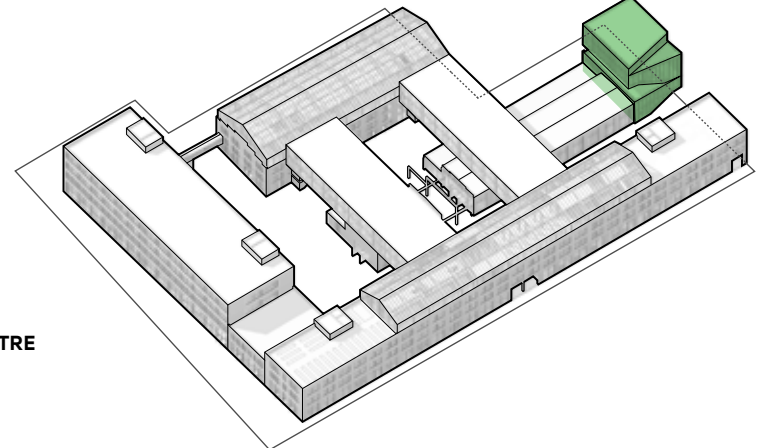

TRANSPORT+ZONING

**TRANSPORT
LOGISTICS**

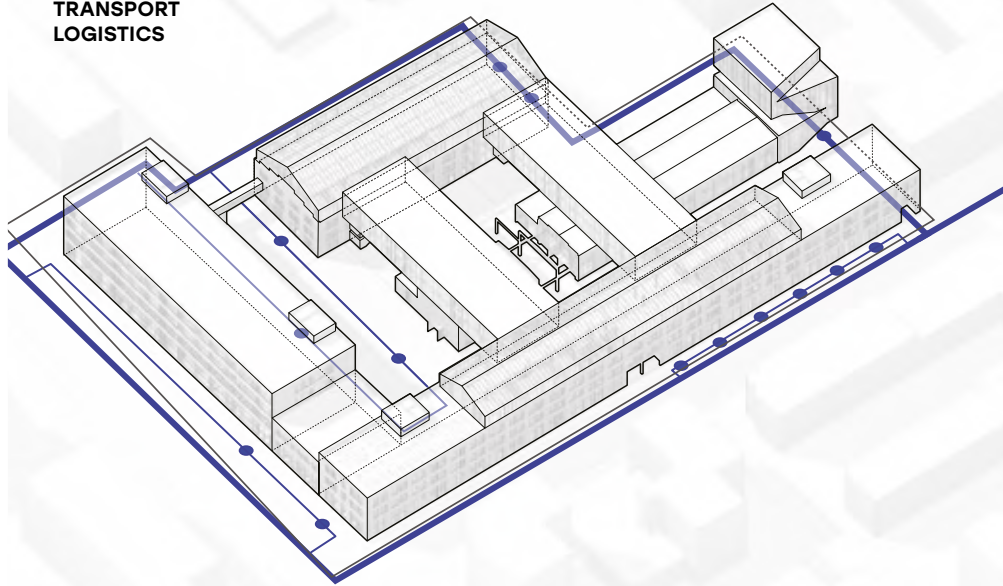

PEDESTRIANS
(internal paths through the building)

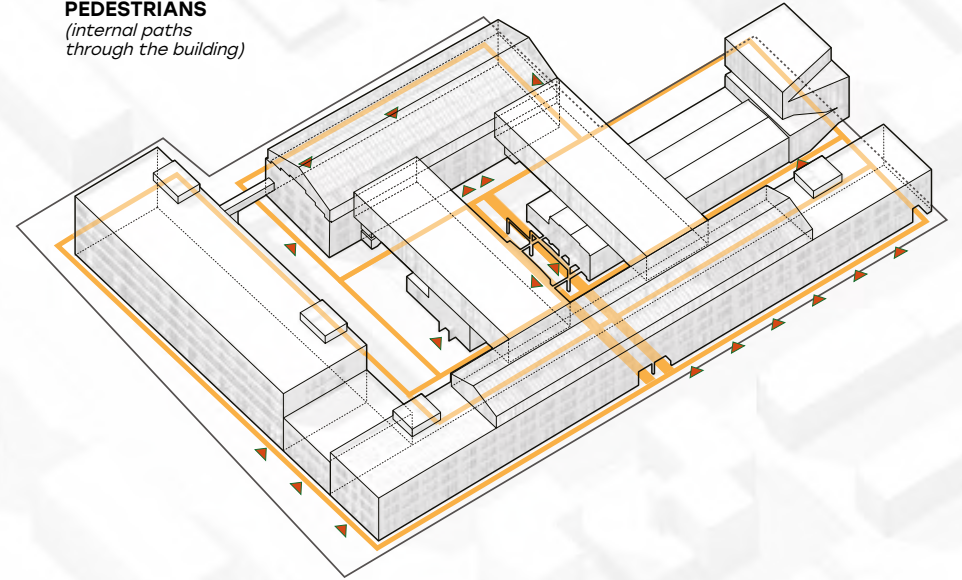

**GREEN ZONES
AND SQUARES**

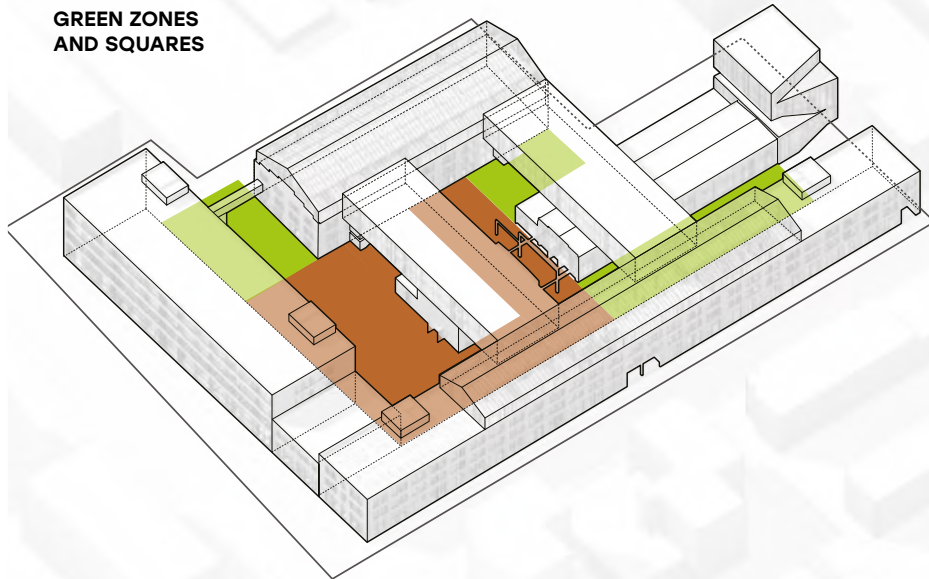

**ROOFS
EXPLOITATION**

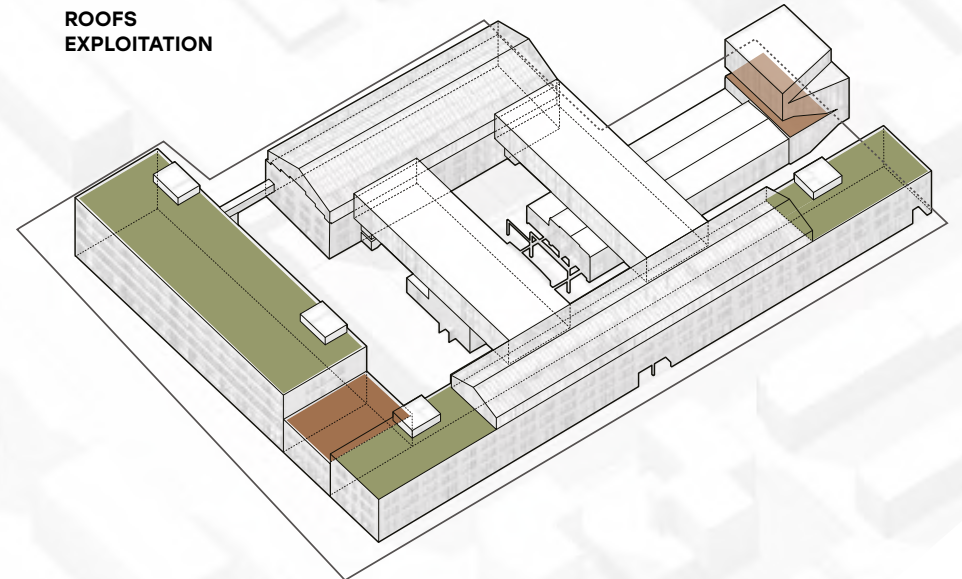

1 LEVEL

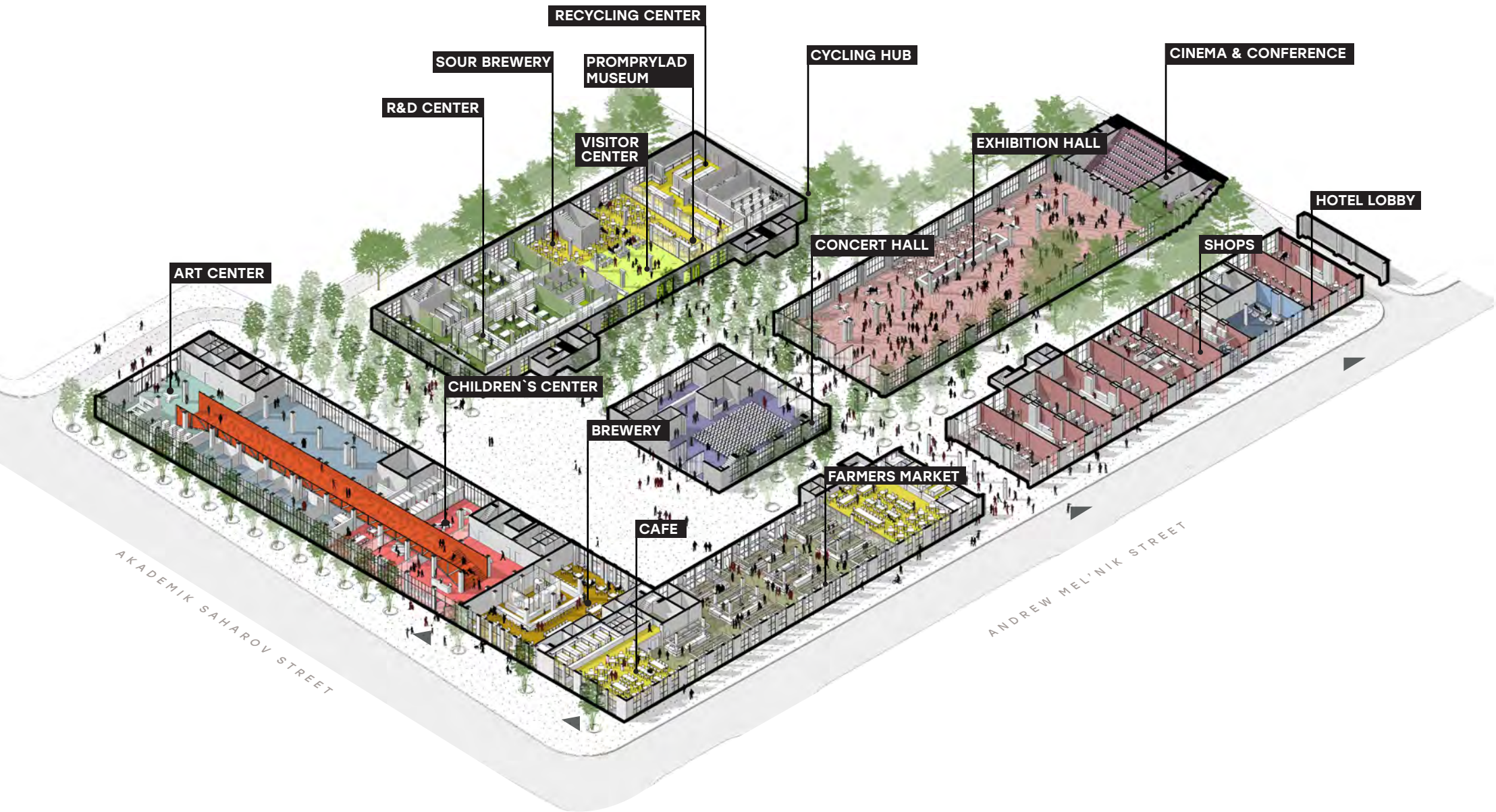

2 LEVEL

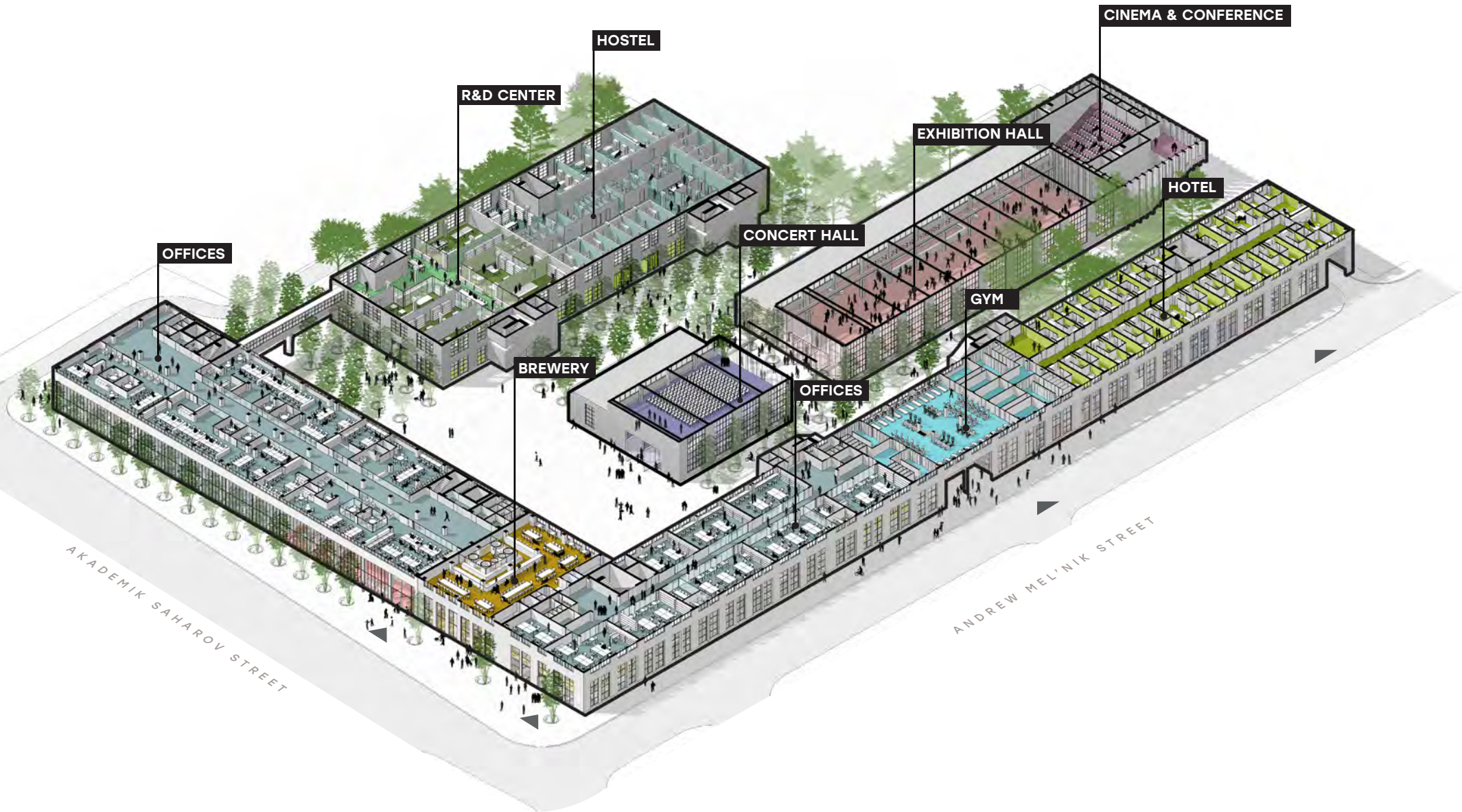

3 LEVEL

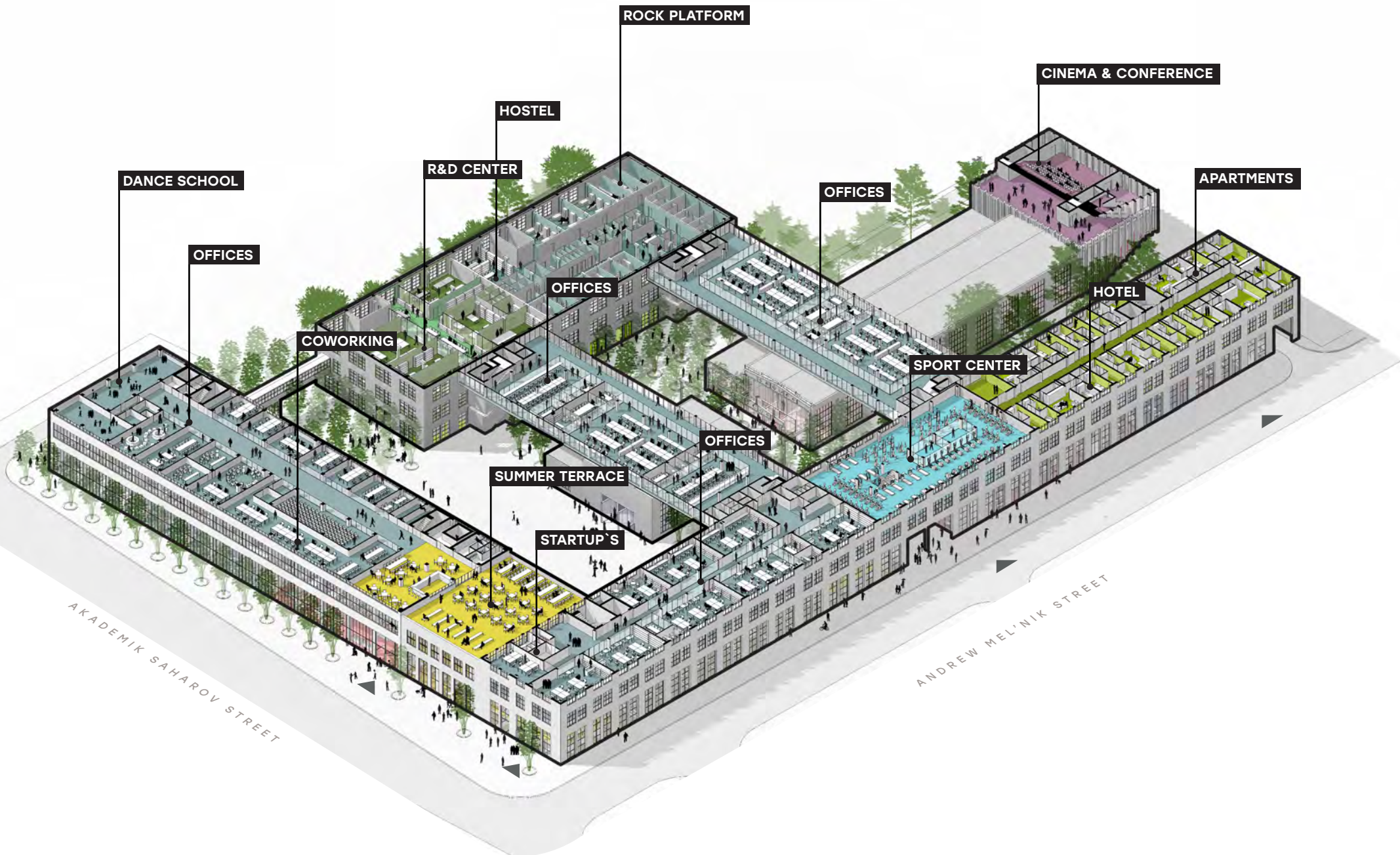

4 LEVEL

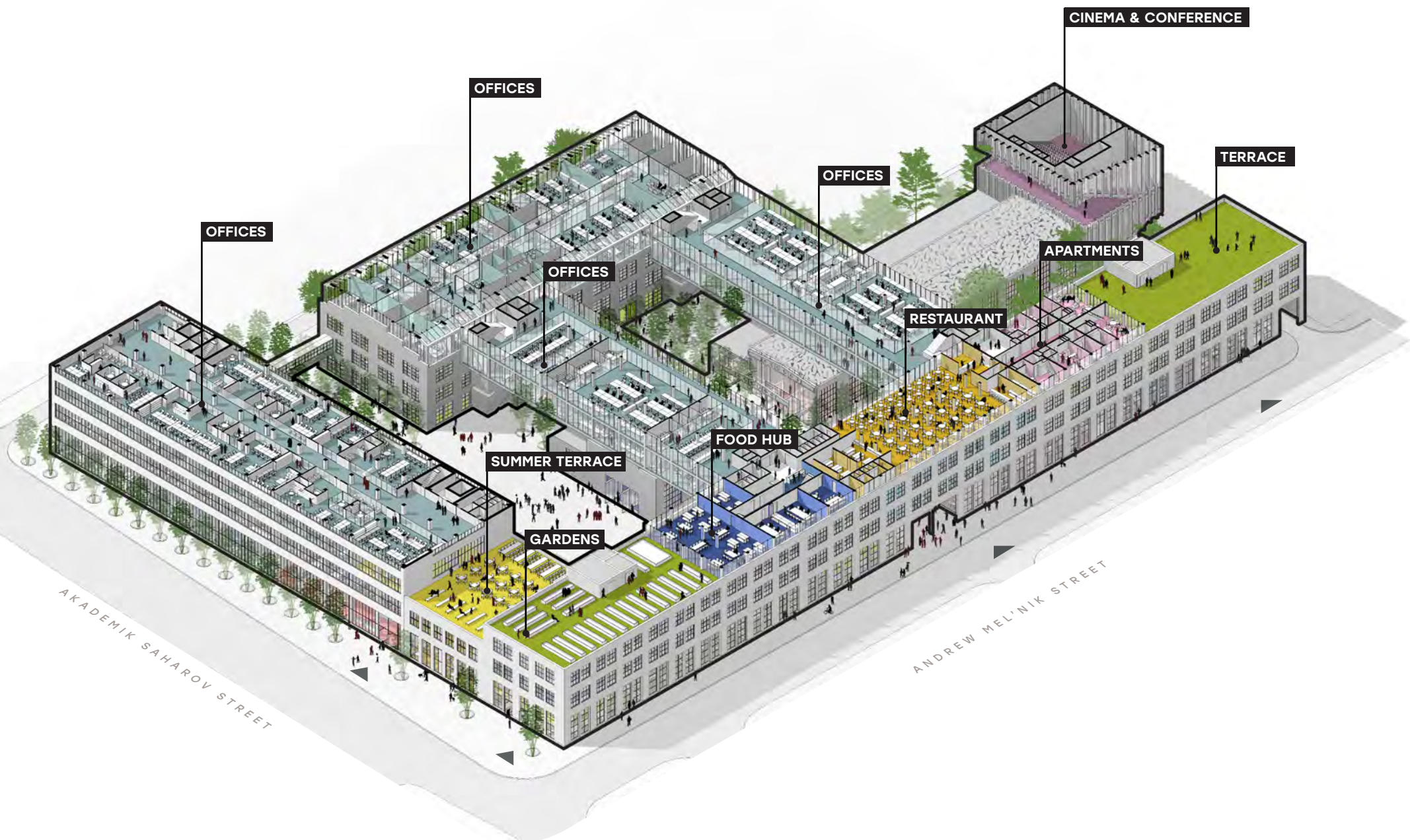

5 LEVEL

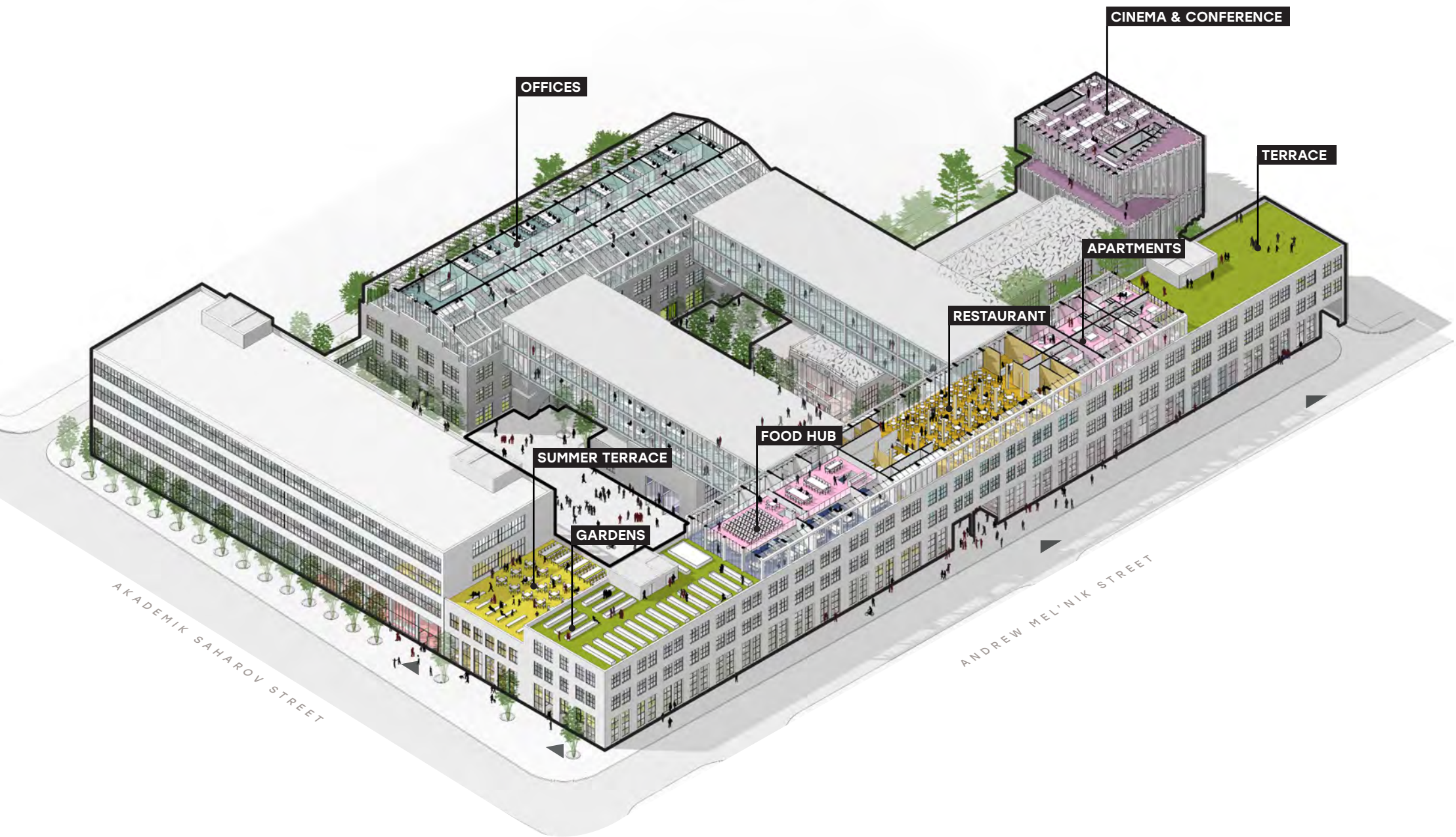





























PILOT PROJECT

PILOT FLOOR

In March 2018, team rented one of the plant floors with an area of 1,789 square meters and has already launched a pilot innovation center there.

Here they united 16 spaces among them urban and multimedia labs, children educational spaces, city investment office, coworking, offices, bar, dance studio and barber school.

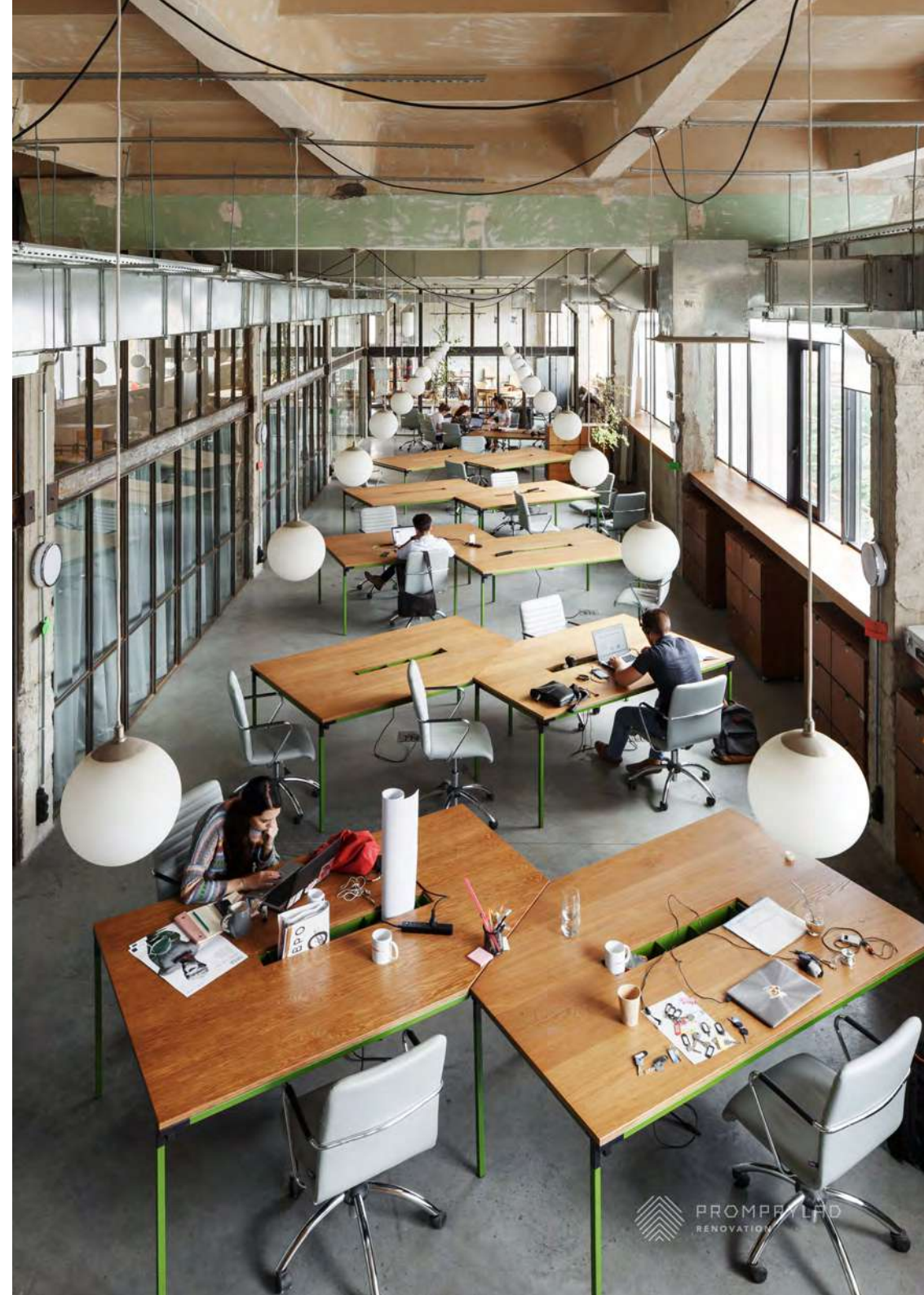

PILOT FLOOR

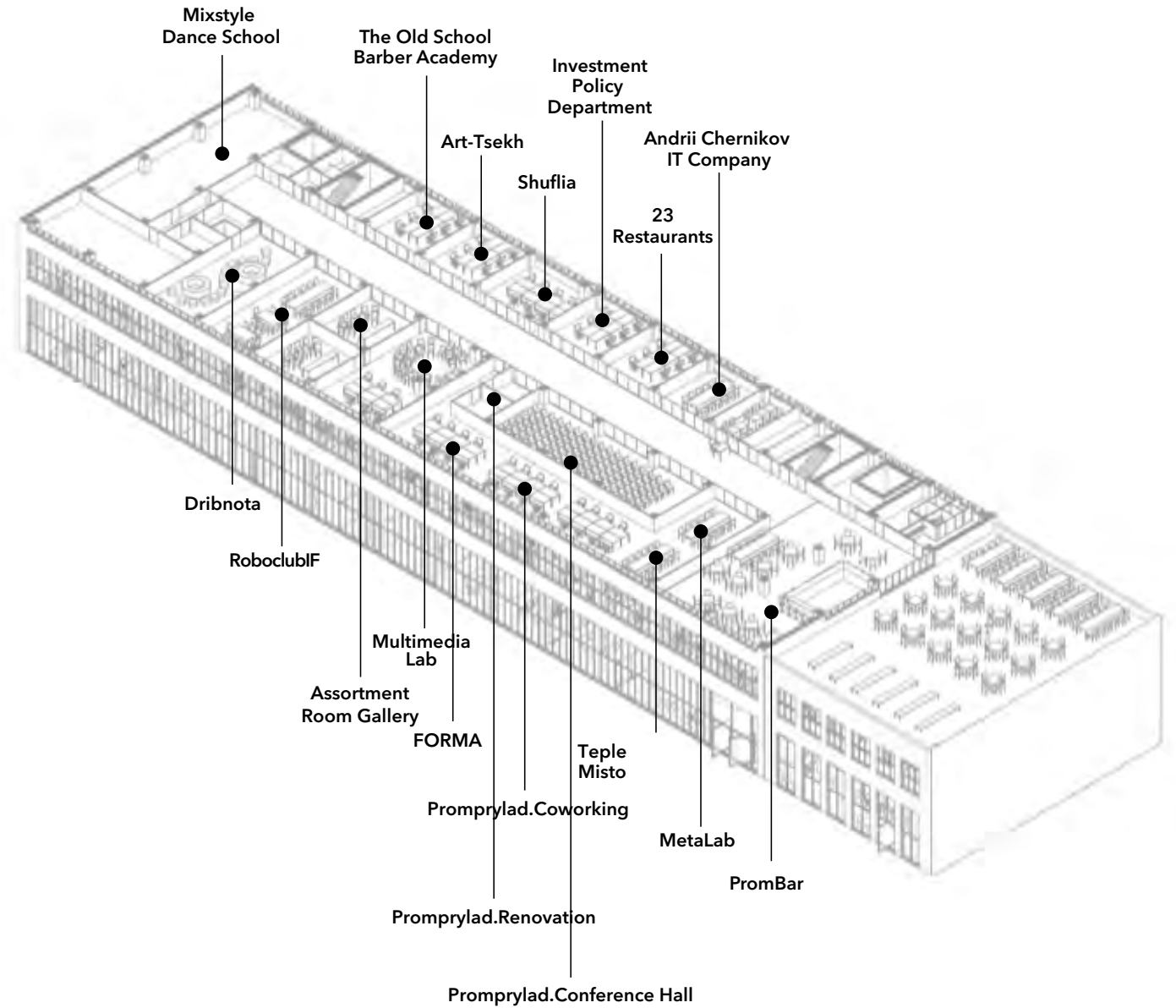

16
SPACES

1 789 M²
RECONSTRUCTED AREA

9 MONTHS
RECONSTRUCTION FINISHED IN

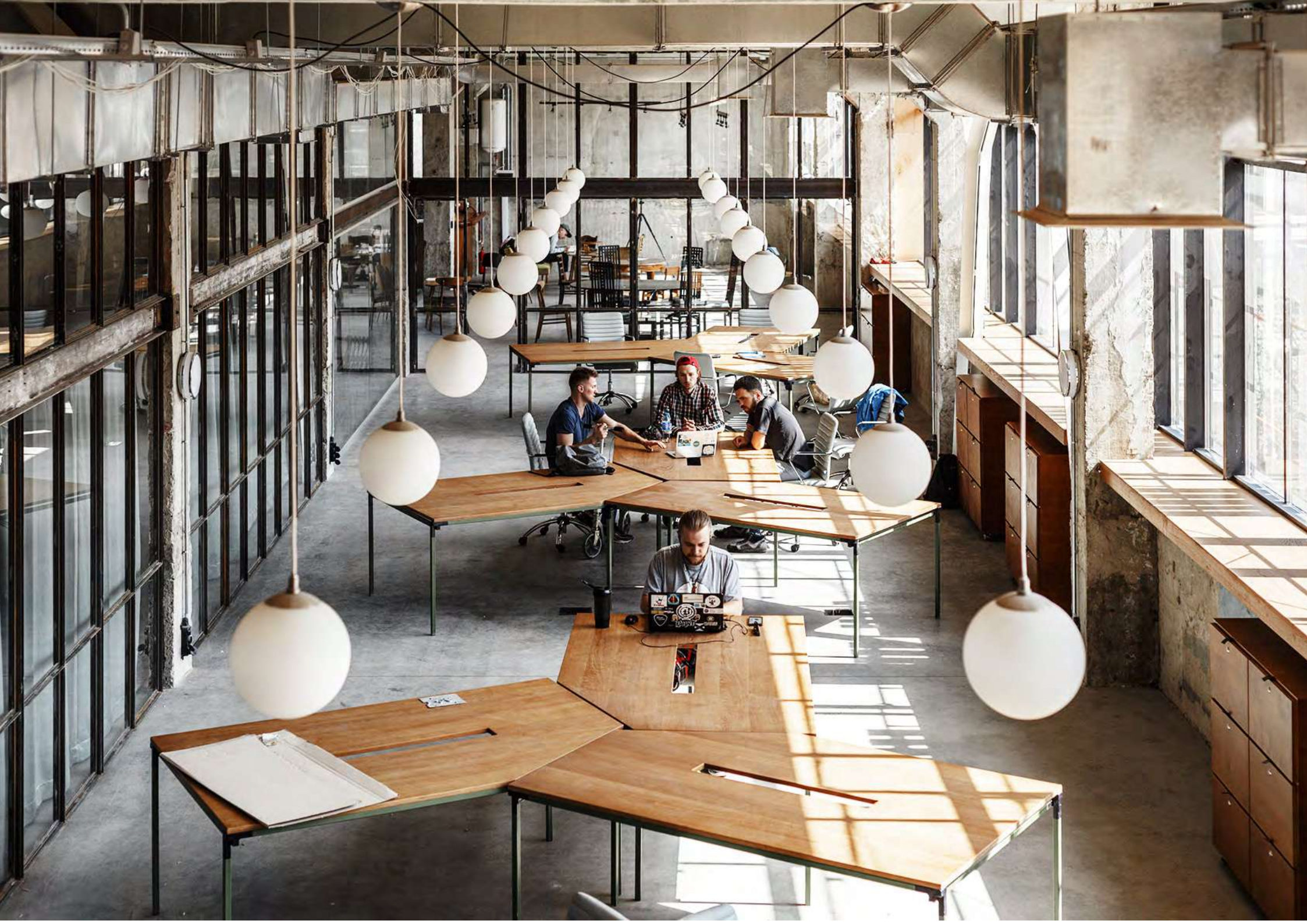



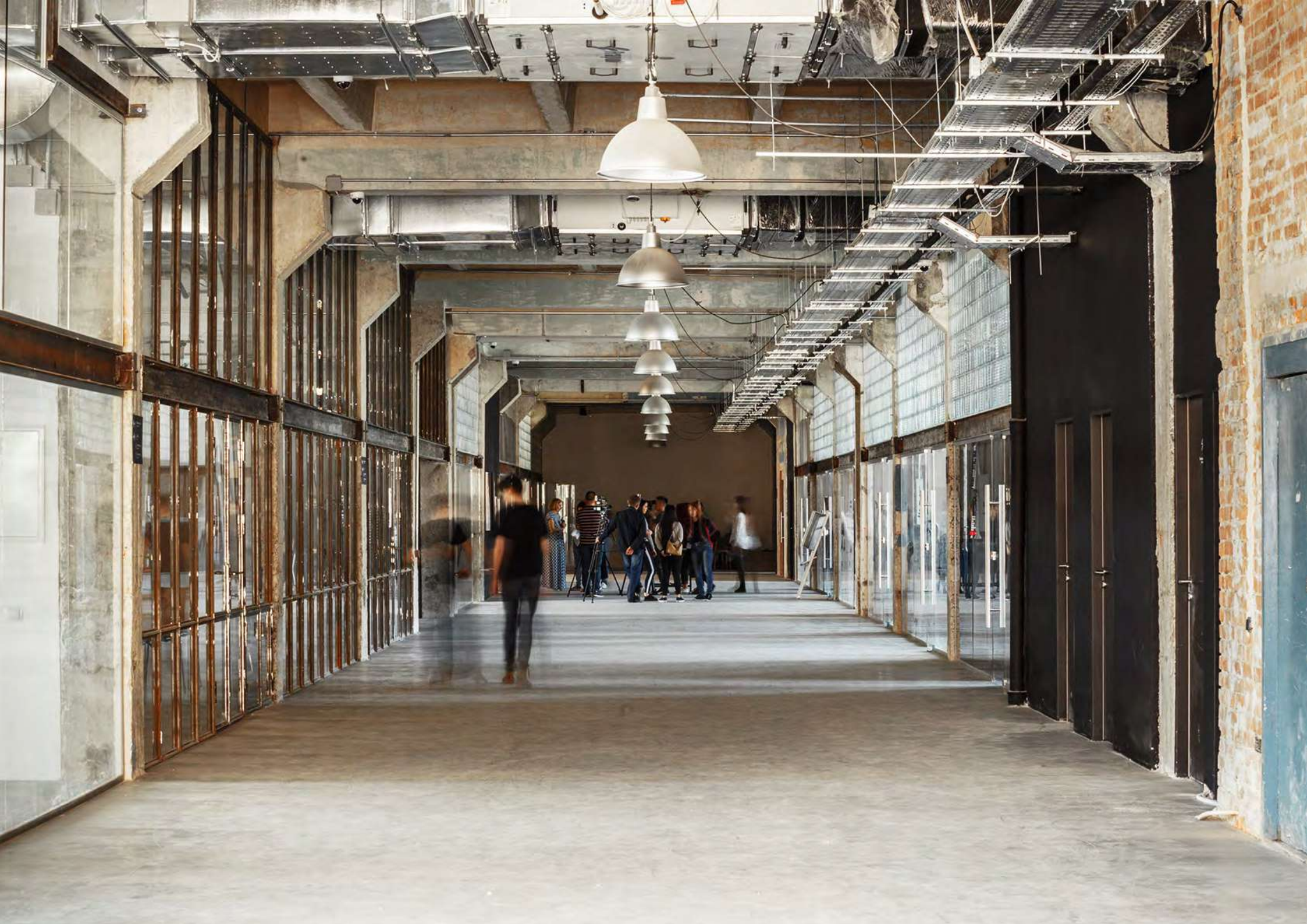

РОЗВИТОК АРХІТЕКТУРНИХ
КОНКУРСІВ В УКРАЇНІ

Carina Design



BE A PART
OF CHANGES.
INVEST IN
PROMPRYLAD.
RENOVATION



promprylad.in.ua
investment@promprylad.in.ua
fb.com/promprylad.renovation